

# GLEASON® PowerTrak®

## E Type Model PT60E-BC Parts List

ITEM	DESCRIPTION	PART NO.
1	Outer Link	P60E-98
2	Inner Link—11.00 radius	P60E-01
	" 14.81 radius	P60E-02
	" 20.50 radius	P60E-03
	" 24.12 radius	P60E-04
	" 29.50 radius	P60E-05
	" 36.00 radius	P60E-06
3	Anti-friction Plate	028922
4	Bar Carrier ( <i>Specify Gleason Serial Number</i> )	
5	Whiz-Lock Bolt, M8-1.25 x 16	028911
6	Hinge Pin	P04-74
7	Retaining Ring	111538
8	Shim Washer, 1.03 ID x .01 thick	028915
9	Shim Washer, 1.03 ID x .02 thick	028916
10	Mounting Bracket, L.H.	P07-345
11	Mounting Bracket, R.H.	P07-346

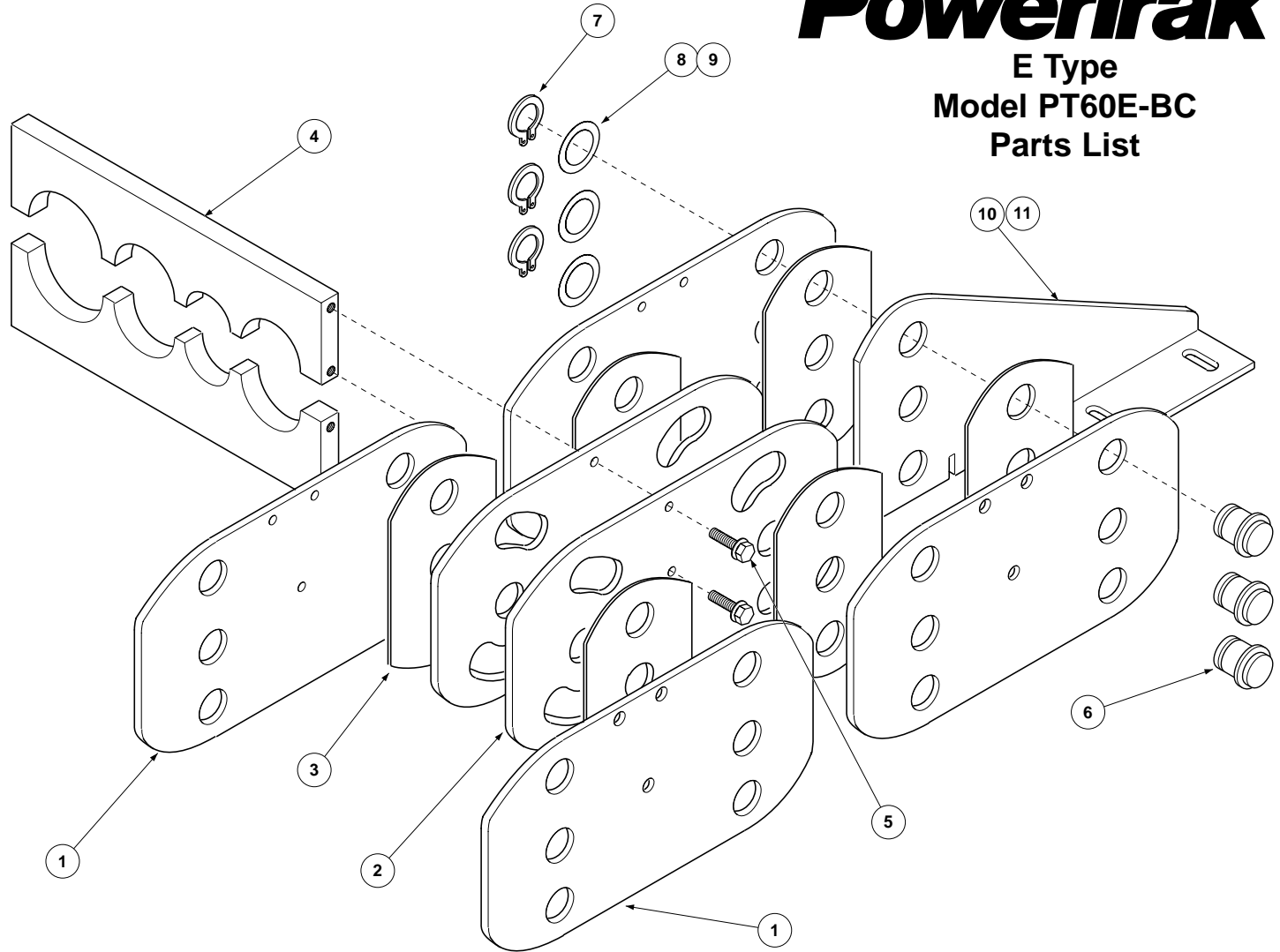

**GLEASON REEL CORP.**  
P.O. Box 26 • 600 South Clark St.  
Mayville, WI 53050-0026  
Phone 920-387-4120 • Fax 920-387-4189