

GLEASON® PowerTrak

E Type Model PT55E-WC Parts List

ITEM	DESCRIPTION	PART NO.
1	Outer Link	P55E-98
2	Inner Link—11.22 radius	P55E-01
	" 15.00 radius	P55E-02
	" 18.69 radius	P55E-03
	" 24.31 radius	P55E-04
	" 30.00 radius	P55E-05
	" 36.00 radius	P55E-06
3	Anti-friction Plate	028054
4 & 5	—See Below—	
6	Hinge Pin	P04-74
7	Retaining Ring	111538
8	Shim Washer, 1.03 ID x .01 thick	028915
9	Shim Washer, 1.03 ID x .02 thick	028916
10	Skt. Hd. CSCR, M6-1.0 x 16	028920
11	Lockwasher, M6	028912
12	Mounting Bracket, L.H.	P07-331
13	Mounting Bracket, R.H.	P07-332

CARRIER WIDTH	ITEM 4 CHANNEL WELDMENT	ITEM 5 CHANNEL CARRIER
6.00"	02890001	02889501
8.00"	02890002	02889502
10.00"	02890003	02889503
12.00"	02890004	02889504
14.00"	02890005	02889505
16.00"	02890006	02889506
18.00"	02890007	02889507
20.00"	02890008	02889508
22.00"	02890009	02889509
24.00"	02890010	02889510

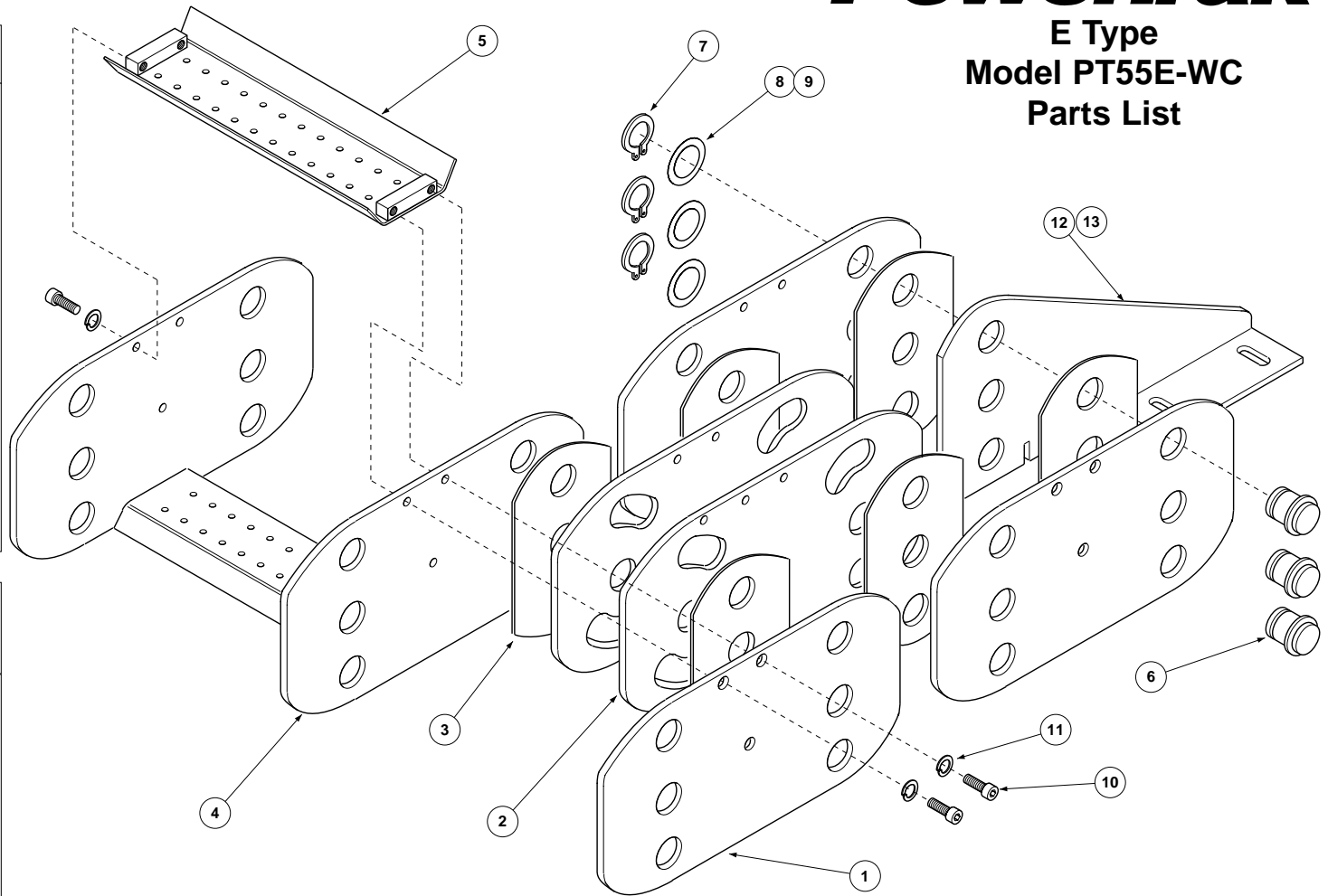

GLEASON REEL CORP.
P.O. Box 26 • 600 South Clark St.
Mayville, WI 53050-0026
Phone 920-387-4120 • Fax 920-387-4189