

# INSTALLATION and MAINTENANCE INSTRUCTIONS 14", 16", 19" SPRING OPERATED ELECTRIC CABLE REELS



**NOTE:** These instructions are written for machine pull reels.  
If installing or servicing hand pull reel, use only those steps marked with hand .

**With Old Dog & Ratchet Design, Mfg. Before 1-1-10**

All units are provided with right hand rotation unless otherwise specified. This means that spool rotates counter-clockwise to wind cable **when viewing reel from slip ring side.**



Clock-type springs provide power for cable take-up. **Spring must be pretensioned at time of installation** to insure that tension is applied to cable at all times.

## INSTALLATION





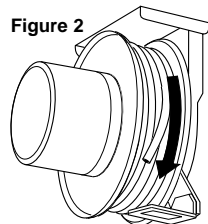
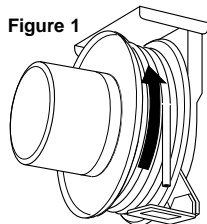

1. If reel is supplying power to a machine, insure that machinery is at position closest to reel.

### CAUTION

If mounting overhead, provide safety chain between reel base and mounting surface to prevent accidental reel drop.

-  2. Securely mount reel in desired position using 3/8" (M10) bolts. Be sure spool centerline is aligned with cable run.
-  3. Position cable guide. Guide must be oriented so cable pays off reel **in a straight line** without bends.
-  4. Remove cable stop. Rotate spool counter-clockwise (when viewed from slip ring side) until all cable is wound on reel...not extending through cable guide. See fig. 1.



-  5. Pre-tension reel by rotating spool in clockwise direction (when viewed from slip ring side). Full 360° turns should match last digit in model number on serial plate. See fig. 2.
-  6. Engage ratchet lock to prevent spool from unwinding.
-  7. Feed cable end out through cable guide and pay-out cable to maximum working length. At least one turn of cable should remain on spool. If spool locks up prior to reaching required length, either reel was over-tensioned during step 5 or reel capacity has been exceeded. Failure to correct this condition will result in shortened spring life and possible damage to other reel components.
-  8. Attach and adjust cable stop. Complete cable working end connections.
9. If machine pull application or if no-lock operation is desired, disengage ratchet lock. See following section.
-  10. Remove slip ring cover and connect individual supply conductors to slip ring leads. Replace cover.
-  11. Turn on power to reel.

## RATCHET LOCK





Reel is shipped with ratchet lock "engaged". If constant spring tension is required, lock may be disengaged by locating and removing the selector plate anchor screw on the frame, rotating the selector plate to disengage position, and replacing and tightening the selector plate screw.

## MAINTENANCE

Bearings and springs are prelubricated and require no periodic maintenance.





## SPRING REPLACEMENT

The unique SAFETYCHANGE® spring motor consists of a spring sealed within a housing. A preplacement spring is supplied sealed in its housing and the old unit should be discarded completely.







-  1. Turn off all electric power.
-  2. Disconnect cable from working end connections.
-  3. Wind cable onto reel to relieve **all** spring tension.
-  4. Using a 3/16" Allen wrench, loosen socket head screw in main shaft clamp nut. Support spool and spin nut off shaft.

### WARNING

Do not attempt to remove spring from its housing. Clock-type springs can be dangerous to handle. Removal of spring from housing could result in personal injury.



-  5. Remove entire spool and spring motor assembly from frame.
-  6. Remove V-Ring seal from spring assembly.
-  7. Remove nuts holding spring assembly and slide spring assembly off main shaft.
-  8. Slide new spring assembly onto shaft and reassemble reel by reversing above steps.
-  9. Adjust spring tension. Refer to INSTALLATION, Step 5.

## SLIP RING REPLACEMENT

-  1. Turn off all electric power.
-  2. Remove cover from junction box. Disconnect input wiring.
-  3. Engage ratchet lock to prevent spool from rotating.
-  4. Remove locknuts holding slip ring cover and gasket. Remove cover.
-  5. Disconnect cable leads from slip ring terminals.
-  6. Loosen two set screws in collar using 1/8" Allen wrench. Pull slip ring assembly off shaft.
-  7. Install new slip ring assembly on shaft and re-assemble reel by reversing above steps.

## CABLE REMOVAL

Use the following procedure to remove worn or damaged cable from reel prior to installation of new cable.

1. Move machine serviced by reel to a position closest to reel. Spring will still be under pre-tension at this point.
-  2. Turn off all electric power.
-  3. Disconnect cable from machine or other fixtures. Remove cable stop and allow cable to retract onto spool. Ensure all tension is off spring by manually rotating spool (normally counter-clockwise when viewed from junction box side).

CONTINUED ON BACK PAGE 

# ILLUSTRATED PARTS LIST

14", 16", 19" DIRECT DRIVE ELECTRIC CABLE REEL

Always specify SERIAL NUMBER & MODEL NUMBER when ordering parts.

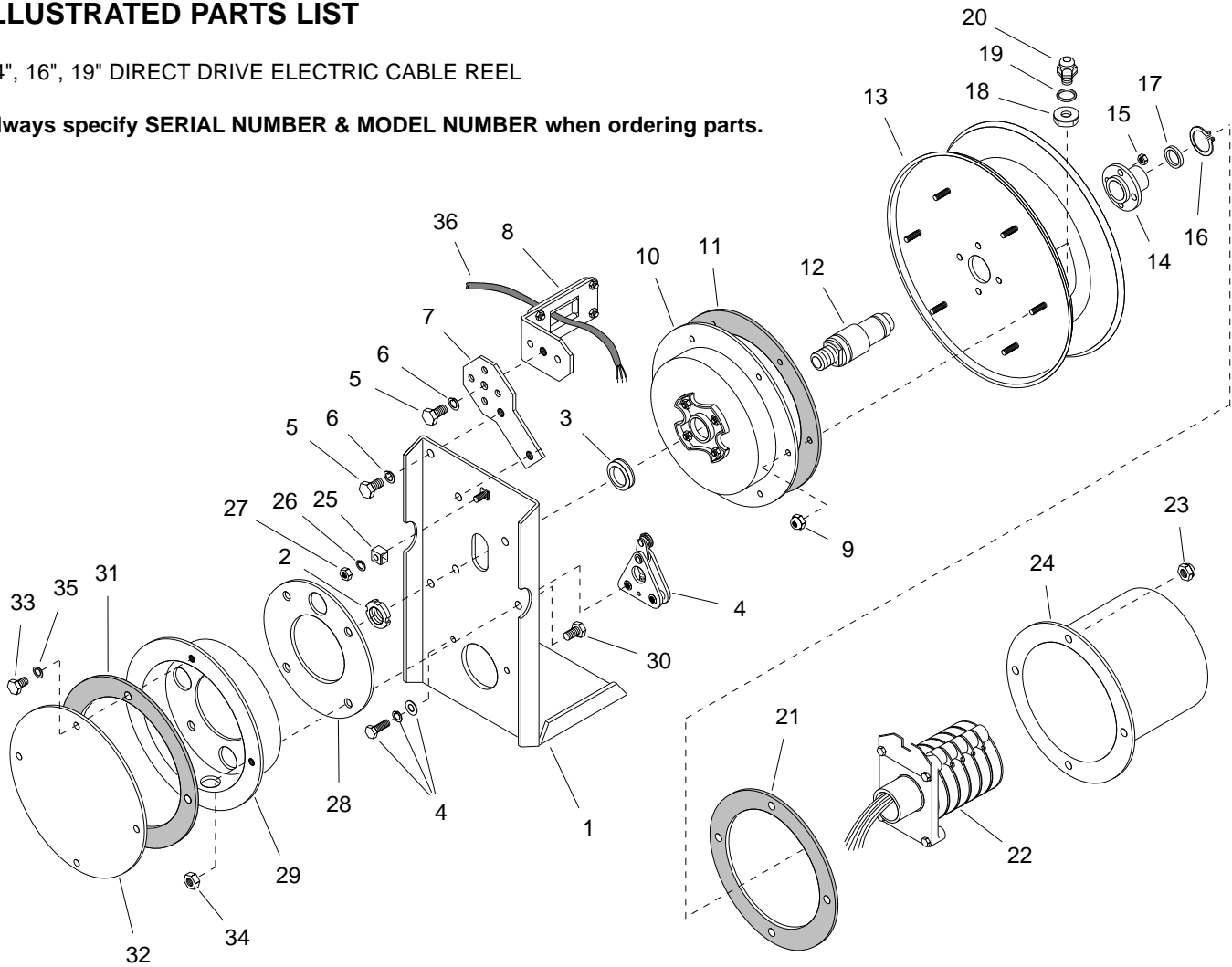

## ELECTRICAL CONNECTIONS

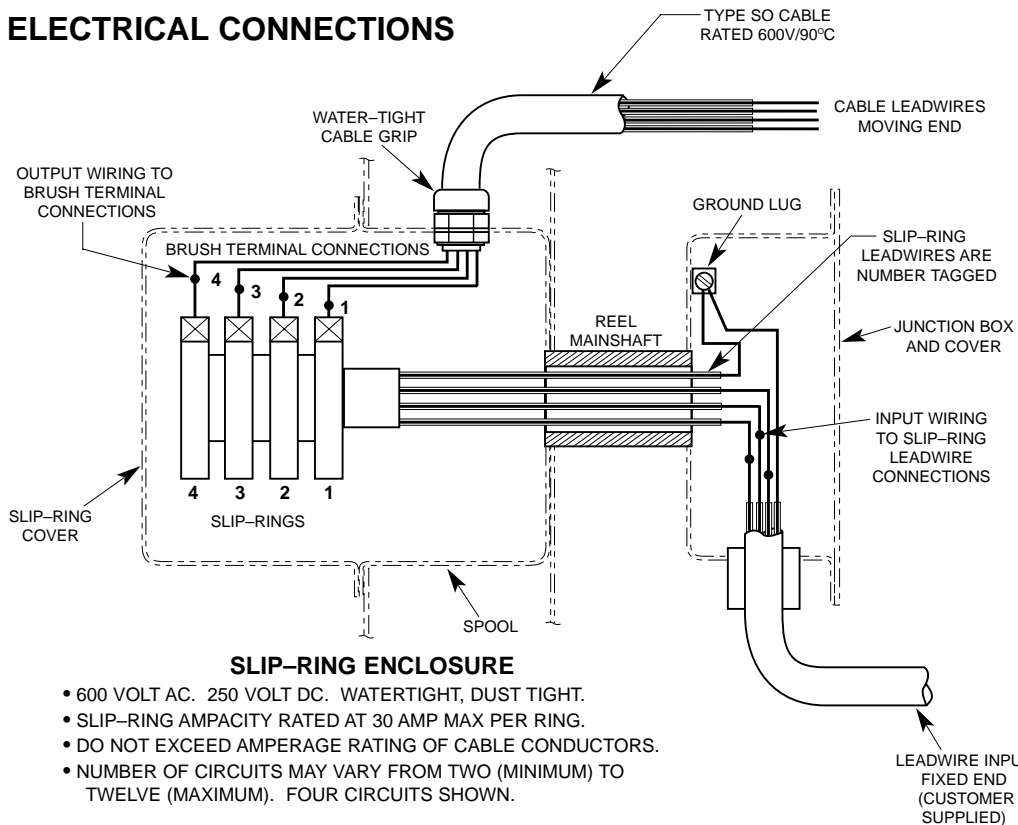

**NOTE:**  
Wire size, wire connectors, connection sequence, and connection methods must comply with National Electrical code and Local Electrical ordinances. If in doubt, contact a local electrical contractor or electrical inspector.

### COLOR SEQUENCE FOR TYPE SO CABLE

**THREE CONDUCTOR CABLE**  
# 1 – BLACK  
# 2 – WHITE  
# 3 – GREEN (ground)

**FOUR THRU TWELVE CONDUCTOR CABLE**  
# 1 – BLACK  
# 2 – WHITE  
# 3 – RED  
# 4 – GREEN (ground)  
# 5 – ORANGE  
# 6 – BLUE  
# 7 – WHITE W/ BLACK TRACER  
# 8 – RED W/ BLACK TRACER  
# 9 – GREEN W/ BLACK TRACER  
# 10 – ORANGE W/ BLACK TRACER  
# 11 – BLUE W/ BLACK TRACER  
# 12 – BLACK W/ WHITE TRACER

### SLIP-RING ENCLOSURE

- 600 VOLT AC. 250 VOLT DC. WATERTIGHT, DUST TIGHT.
- SLIP-RING AMPACITY RATED AT 30 AMP MAX PER RING.
- DO NOT EXCEED AMPERAGE RATING OF CABLE CONDUCTORS.
- NUMBER OF CIRCUITS MAY VARY FROM TWO (MINIMUM) TO TWELVE (MAXIMUM). FOUR CIRCUITS SHOWN.

# 14", 16", 19" DIRECT DRIVE ELECTRIC CABLE REEL REPLACEMENT PARTS LIST

ITEM	KIT NO.	DESCRIPTION	QTY.
1	021456	Frame Assembly, 14" Reel	1
1	028059	Frame Assembly, 16" Reel	1
1	021646	Frame Assembly, 19" Reel	1
2	021484	Clamp Nut	1
3	025032	'V'-Ring Seal	1
4	604093	Locking Dog Repair Kit (Includes mounting hardware)	1
5	028132	Hex Head Capscrew, M10 x 25L	3
6	028138	Lockwasher, M10	3
7	021527	Mount Bracket, 14" Reel	1
7	028075	Mount Bracket, 16" Reel	1
7	023417	Mount Bracket, 19" Reel	1
8	024466	Roller Guide Assembly, 14" Reel	1
8	028071	Roller Guide Assembly, 16" Reel	1
8	024473	Roller Guide Assembly, 19" Reel	1
9	028144	Lock Nut, M5 x 0.8, 14" & 16" Reel	6
9	028144	Lock Nut, M5 x 0.8, 19" Reel	8
10	05059801	Spring Assembly "A11", 14" Reel	1
10	05059802	Spring Assembly "B11", 14" Reel	1
10	05059803	Spring Assembly "C11", 14" Reel	1
10	05059804	Spring Assembly "D11", 16" & 19" Reels	1
10	05059806	Spring Assembly "E11", 16" & 19" Reels	1
10	05059809	Spring Assembly "G11", 16" & 19" Reels	1
10	05059810	Spring Assembly "H11", 16" & 19" Reels	1
10	05059811	Spring Assembly "J11", 16" & 19" Reels	1
10	05059813	Spring Assembly "K11", 16" & 19" Reels	1
11	021494	Spring Gasket, 14" & 16" Reels	1
11	022734	Spring Gasket, 19" Reel	1
12	027445	Shaft, 14" Reel	1
12	028060	Shaft, 16" Reel	1
12	027401	Shaft, 19" Reel	1
13	027412	Spool Assembly, 14" Reel	1
13	02806603	Spool Assembly, 16" Reel	1
13	027408	Spool Assembly, 19" Reel	1
14	027444	Flange Bushing, 14" Reel	1
14	028061	Flange Bushing, 16" Reel	1
14	027409	Flange Bushing, 19" Reel	1
15	028144	Lock Nut, M5 x 0.8	4
16	107185	Retaining Ring, 14" & 16" Reel	1
16	027406	Retaining Ring, 19" Reel	1
17	027456	Thrust Washer, 14" & 16" Reel	1
18	021513	Counter Nut	1
19	104336	O-Ring	1
20	022805	Cable Connector, 0.38-0.50 Cable Dia.	1
20	021510	Cable Connector, 0.50-0.70 Cable Dia.	1
20	021511	Cable Connector, 0.70-1.00 Cable Dia.	1

ITEM	KIT NO.	DESCRIPTION	QTY.	
21	018042	Cover Gasket, 14" & 16" Reel	1	
21	021494	Cover Gasket, 19" Reel	1	
22	602733	Slip Ring Assembly, 1-4 Pole, 30A	1	
22	602734	Slip Ring Assembly, 5-8 Pole, 30A	1	
22	602735	Slip Ring Assembly, 9-12 Pole, 30A	1	
22	602736	Slip Ring Assembly, 1-4 Pole, 55A	1	
22	602737	Slip Ring Assembly, 1-4 Pole, 75A (19" Reel Only)	1	
23	028144	Lock Nut, M5 x 0.8, 14" & 16" Reel	4	
23	028144	Lock Nut, M5 x 0.8, 19" Reel	6	
24	02149603	Slip Ring Cover, 1-4 Pole, 14" & 16"	1	
24	02149604	Slip Ring Cover, 5-8 Pole, 14" & 16"	1	
24	02149605	Slip Ring Cover, 9-12 Pole, 14" & 16"	1	
24	02270501	Slip Ring Cover, 1-4 Pole, 19" Reel	1	
24	02270502	Slip Ring Cover, 5-8 Pole, 19" Reel	1	
24	02270503	Slip Ring Cover, 9-12 Pole, 19" Reel	1	
25	01555101	Grounding Lug	1	
26	028139	Lockwasher, Internal Tooth	1	
27	028144	Lock Nut, M5 x 0.8	1	
28	021479	Gasket, Junction Box	1	
29	021480	Junction Box	1	
30	028131	Hex Head Capscrew, M10 x 20L	3	
31	018042	Cover Gasket	1	
32	018043	Junction Box Cover	1	
33	028136	Taptite Screw, M6 x 1 6L	4	
34	028146	Lock Nut, M10 x 1.5	3	
35	028140	Lockwasher, M6	4	
36	See Nameplate	Cable, Model Number**	1	
<b>OPTIONAL ACCESSORIES</b>				
	022450	Cable Stop, 0.38"-0.50" Dia. Cable	Option	
	022451	Cable Stop, 0.50"-0.75" Dia. Cable	Option	
	022452	Cable Stop, 0.75"-1.00" Dia. Cable	Option	
	022217	Swivel Base, 14" Reel	Option	
	028056	Swivel Base, 16" Reel	Option	
	022220	Swivel Base, 19" Reel	Option	
<b>MODEL NUMBER CODE</b>				
Reel Series	Cable	Number Conductors	Spring	Pretension Required
<b>C14</b>	- <b>A</b>	<b>03</b>	- <b>B11</b>	- <b>02</b>
<b>CABLE CHART</b>				
<b>A=16 AWG</b>	<b>B=14 AWG</b>	<b>C=12 AWG</b>	<b>D=10 AWG</b>	
<b>E=8 AWG, Type W</b>		<b>F=8 AWG, Grounded</b>		

- 4. Remove cable from spool by looping over spool flange and slip ring cover.
- 5. Remove slip ring cover
- 6. Disconnect cable leads from slip ring brush terminals.
- 7. Loosen counternut on cable connector in spool and pull cable out.

**⚠ CAUTION**  
 Failure to relieve all spring tension prior to removing cable could result in damage to equipment or personal injury. Follow instructions carefully.

- 8. Install new cable following directions below.

**CABLE INSTALLATION**

Use the following procedure to replace cable or if reel was ordered without cable. Refer to CABLE INSTALLATION REFERENCE DRAWING, below.

- 1. Unspool new cable from shipping spool and lay out to eliminate twist.  
 NOTE: This step is not essential, but will aid in winding operation of the reel and prolong cable life.
- 2. Remove slip ring cover.
- 3. Loosen counter nut on cable connector (nut is inside slip ring housing).
- 4. Feed one end of the cable through cable connector in spool and into the slip ring side. (See drawing below).
- 5. Connect individual conductors to appropriate collector brushes on slip ring assembly using crimp fitting or similar connection method.
- 5. Tighten cable connector in spool. **Do not over-tighten.**

- 6. Wind the cable onto the reel spool by hand rotating spool in direction it turns free of spring tension. (Normally counter-clockwise when viewed from junction box side)
- 7. Replace slip ring cover and gasket.
- 8. Complete working end connections. Adjust cable stop.
- 9. Pretension reel and complete installation as described in INSTALLATION section.

**SPRING ADJUSTMENT**

Adjust tension by adding wraps (increasing tension) or removing wraps (decreasing tension) from the spool.

**⚠ WARNING**  
 If machine pull reel, move machinery to position closest to reel before adjusting spring tension. Adjusting tension with cable extended may result in damage to reel or personal injury.

- 1. Pull about 10" of cable, allowing spool to rotate.

**INCREASE TENSION:** Without allowing spool to rotate, hand feed cable through hose guide until loop is large enough to slip onto spool. **Add** two or three wraps until desired tension is achieved. See Figure 3.

**DECREASE TENSION:** Without allowing spool to rotate, hand feed cable back through guide to provide slack. **Remove** one or two wraps from spool. See Figure 4.

- 2. Test reel operation.

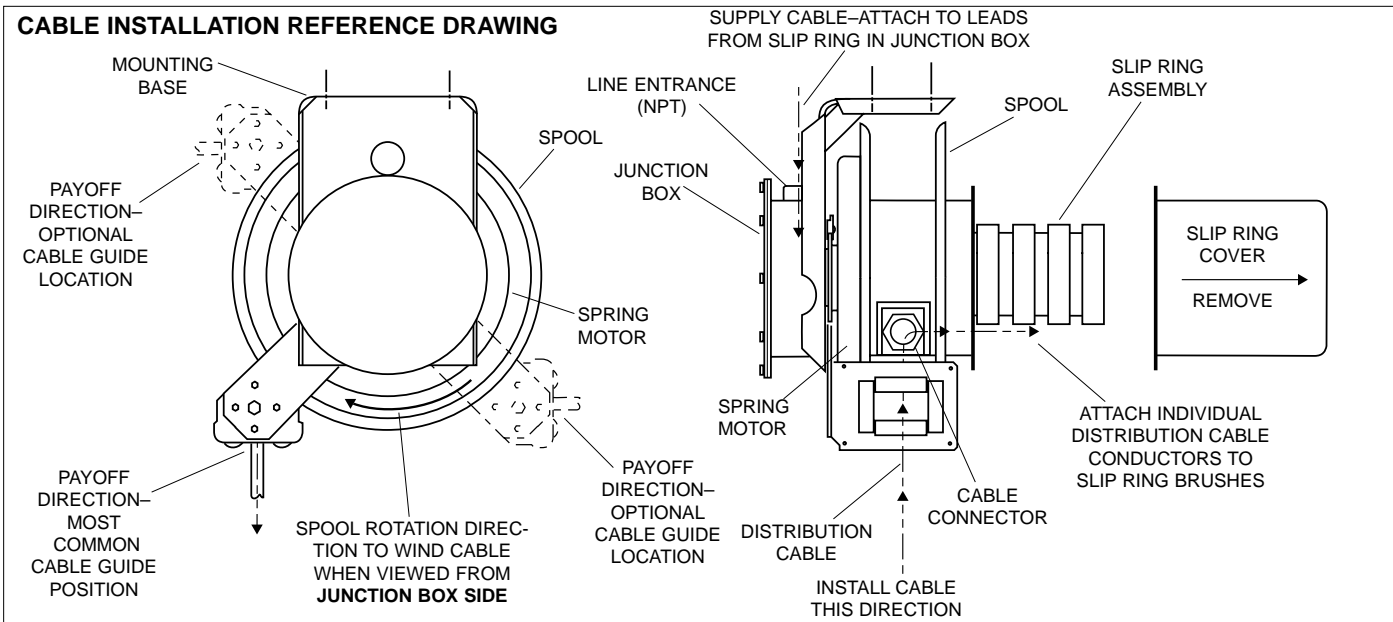
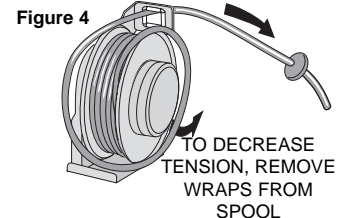
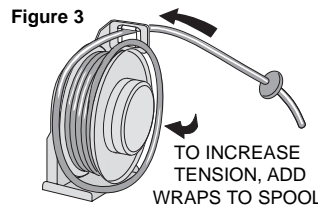

**GLEASON REEL CORP.**  
 P.O. Box 26 • 600 South Clark St.  
 Mayville, WI 53050-0026  
 Phone 920-387-4120 • Fax 920-387-4189